

Visitor Counter and Information Viewer at Photo Exhibitions using Embedded Systems and Web Services

I Made Bhaskara Gautama¹, I Gusti Ngurah Wikranta Arsa², Ni Putu Virgi Savita³

^{1,2,3} Institut Teknologi dan Bisnis STIKOM Bali
Denpasar, Indonesia

e-mail: ^{1*}bhaskara@stikom-bali.ac.id

Abstrak - Fotografi merupakan sebuah seni dan penghasilan gambar dan cahaya pada film atau permukaan yang dipeka. Fotografi menjadi seni yang banyak digemari mulai dari sekedar hobi hingga sebagai mata pencaharian. Berbagai *event* fotografi pun digelar seperti misalnya pameran foto. Pameran ini bertujuan untuk memperlihatkan sebuah karya seni ke khalayak ramai atau untuk mempromosikan karya seni yang dapat menguntungkan bagi pemilik karya. Salah satu permasalahan yang timbul dari pameran foto ini adalah adanya kebutuhan dari pemilik karya atau penyelenggara *event* untuk mengetahui seberapa banyak sebuah foto dikunjungi/dilihat secara seksama oleh seseorang. Hal ini dapat menjadi indikator terhadap minat/ketertarikan masyarakat terhadap suatu karya. Penghitungan secara manual kurang efektif untuk dilakukan mengingat banyaknya foto yang dipamerkan. Oleh karena itu, diperlukan sebuah alat yang dapat diproduksi massal dengan biaya relatif murah untuk mendeteksi pengunjung pada *site* foto. Alat yang dibuat berbasis mikrokontroler (*embedded system*) yang juga menggunakan konsep IoT. Alat dibuat menggunakan mikrokontroler NodeMCU dan sensor PIR. Berdasarkan hasil pengujian, alat yang dibuat mampu menghitung pengunjung dengan tingkat akurasi 82% dan berhasil menampilkan informasi ketika pengunjung terdeteksi dan menyembunyikan informasi ketika pengunjung meninggalkan area deteksi.

Kata Kunci: fotografi, mikrokontroler, IoT.

Abstract - Photography is the art and production of images and light on a film or sensitized surface. It becomes a popular art as a hobby or for a living. Thus, many photography events are held such as photo exhibitions. The exhibition aims to show the work of art to the public or to promote the work so it can be profitable for the artist. One of the problems that arise from this photo exhibition is the need for the owner of the work or the event organizer to find out how many people have visited/seen a photo earnestly. This can be an indicator of public interest in the artwork. Counting manually is less effective to do considering the number of photos on display. Therefore, we need a tool that can be mass-produced at a relatively low cost to detect visitors to the photo site. The tool is based on a microcontroller (*embedded system*) which also uses the IoT concept. The tool is made using a NodeMCU microcontroller and PIR sensor. Based on the test results, the tool can count visitors with an accuracy rate of 82% and successfully displays information when visitors are detected and hides information when visitors leave the detection area.

Keywords: photography, microcontroller, IoT.

INTRODUCTION

Photography is the art of producing images by using light on a film or a sensitized surface (Pebriany & Sanusi, 2020). This art can be done using a camera, with the lens as its main part. A camera lens mimics how the eyes work by trapping light reflected by an object. The captured light is used to burn a light-sensitive media chemically, to produce a shadow that is identical to the photo object. Along with the development of technology, the method of taking pictures is changed by using an image sensor (Irawan

& Deli, 2021). Likewise, photography along with its techniques has also developed along with the development of the devices used to take pictures. Photography has become a popular art as a hobby or for a living (Arbi & Dewi, 2017). Thus, many photography events are held such as photo exhibitions. Photos on display can be in print or digital form. The exhibitions aim to show works of art to the public and get feedback such as opinions or interest from them. In addition to the photos on display, usually, it is also included with information about the photo. For example, the title, where the

Article Information

Received: August 30,
2022

Revised: September 2,
2022

Accepted: September 6,
2022



photo was taken, the photo model, and so on. One of the problems that arise from this photo exhibition is the need for event organizers to find out how many people have visited/seen a photo earnestly. This can be an indicator of public interest in the artwork. Counting manually is less effective to do considering the number of photos on display. In addition, filling out visitor forms manually by visitors is also less effective because it depends on the awareness of visitors to fill out the form.

Based on these problems, it is necessary to make a device that can count the number of visits to a photo. Based on previous research, one of the techniques used to count the number of visitors is done using image processing, namely face detection (Inrawansyah, 2017; P et al., 2022). This method was successfully used to calculate the number of visitors to a building and visitors to the library. However, if this method is applied to calculate the number of visitors who view a photo, it will cost a lot because it requires a camera at each photo site and requires high computational capabilities to process images from many cameras. The next technique is to use embedded systems that utilize microcontrollers and sensors, such as Passive Infra-Red (PIR) sensors, ultrasonic sensors, or photodiode sensors (Adella et al., 2020; Almuttaqin & Nasir, 2021; Atika Sari et al., 2020; Fahmawaty et al., 2020). Some of these studies also use the IoT concept. This technique is more feasible to implement because the cost required to make a device in each photo is relatively cheap.

Based on the results of previous studies, in this study, an embedded system that uses the IoT concept is created. In contrast to previous studies that used a combination of Arduino UNO and Raspberry Pi, this study uses NodeMCU because it already contains a Wi-Fi module so it can reduce the production costs. The sensor used is a PIR sensor. The difference from the previous research, the PIR sensor is placed in a special case to control the range of the sensor. This case is used to prevent the motion is counted as a visit even though visitors are just passing by in front of the photo site. In addition, the device can also display photo information automatically through the projector screen only if there are visitors who look at the photo earnestly. By using this device, it is expected to facilitate the needs of photo exhibition organizers at a relatively low cost for mass production. The device can also be used for other matters with the same purpose.

RESEARCH METHODOLOGY

This research consists of two main elements, which are a visitor detection device and a web server. The visitor detection and counter device are built by using a microcontroller that uses a PIR sensor. When a visitor is detected, the device will send data to the web server. On the web server, visitor data will increase

by one each time the device sends data. The computer that is connected to a projector is used to display photo information when a visitor is detected. The projector device must be connected to a client computer that is connected to the web server and has already opened the web page to display the photo information. The conceptual model of this research is shown in Figure 1.

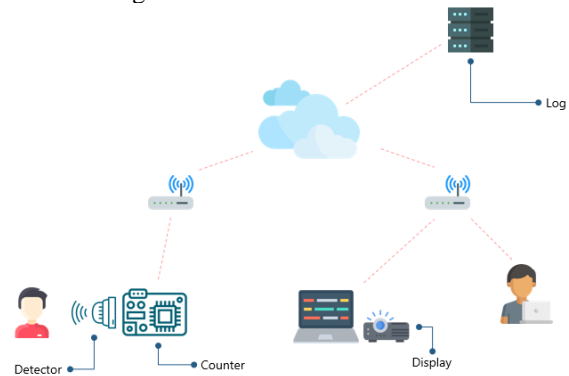

Figure 1. Research conceptual model.

Source: (Gautama et al., 2022)

This research is generally divided into four parts, namely Device Development, Web Service Development, Testing, and Evaluation. Figure 2 below shows the steps or stages carried out in this research.

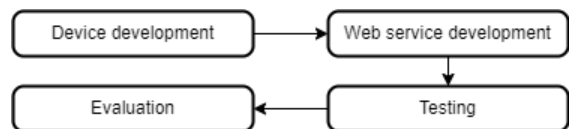

Figure 2. Research stages.

Source: (Gautama et al., 2022)

1. Device Development

Figure 3 below shows the flowchart of device development phases.

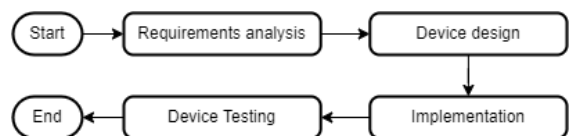

Figure 3. Device development phases flowchart.

Source: (Gautama et al., 2022)

A. Requirements Analysis

At this phase, requirements analysis is carried out from the collected data. The analysis includes how the tool works, hardware and software requirements so that problems can be solved.

B. Device Design

At this phase, the device designs are made. The design of the device is described using a block diagram to show the relationship between the components that are used by the device.

C. Implementation

Implementation is done by assembling the

components of the device according to the design and embedding codes so that the device can send sensor data to the web server.

D. Testing

Testing is done by examining the functionality of the device and whether it can detect visitors as expected and successfully send data to the web server.

2. **Web Service Development**

The website is built using the Agile method because the time to develop the website is limited. Figure 4 shows the Agile method using the Scrum model.

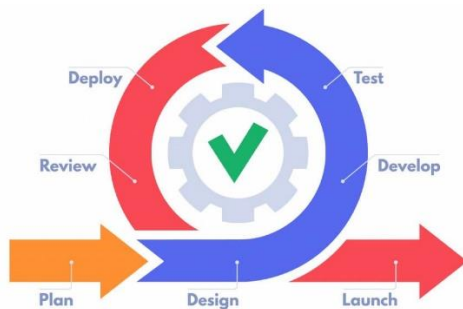

Figure 4. Agile software development.
Source: (Rabbani & Krisnanik, 2020)

Design, implementation, testing, deploying, and reviewing are done repeatedly to complete feature by feature. This iteration is called a Sprint. The website is used to receive sensor data from the device, save it into a database, and display photo information through the projector. The system can also be accessed to find out the number of visits to a photo site.

3. **Device and Web Testing**

This stage was carried out by comparing the actual number of visitors with the number of visitors based on data on the web server. The actual number of visitors is collected using the manual method through a form filled out by visitors.

4. **Evaluation**

Based on the results of the testing, an evaluation was carried out to determine the advantages and disadvantages of the device and web service, as well as suggestions for further research.

RESULTS AND DISCUSSION

1. **Device Development**

A. Requirements Analysis

At this stage, a requirements analysis is carried out based on the data that has been collected. To develop a device, the following components are needed:

- a. Main Components
 - NodeMCU ESP8266

- PIR HC-SR501 sensor
- b. Supporting Component
 - Breadboard
 - Male-to-female jumper cable
 - Type A-to-Micro USB cable

B. Device Design

This stage divided into two parts: (1) Device Model; and (2) Device Algorithm.

a. Device Model

Figure 5 shows a block diagram and the model of the device. The PIR sensor is connected to the NodeMCU which is powered using a USB cable. The PIR sensor has three nodes, namely ground, output, and power input. The black wire is the ground that is connected to the GND pin on the NodeMCU. The yellow wire is the input connected to pin D1 on the NodeMCU. The red wire is the power input connected to pin 3V3 on the NodeMCU.

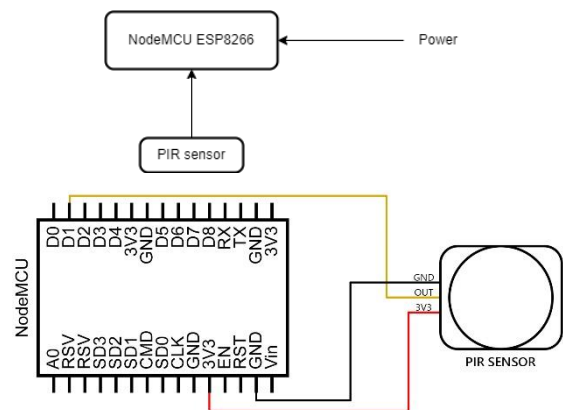

Figure 5. Device block diagram and device model.
Source: (Gautama et al., 2022)

b. Device Algorithm

Figure 6 shows the flowchart of the algorithm that is used in the embedded system. The input from the sensor will be read every second. The potentiometer on the sensor is set as shown in Figure 7. Using these settings, the sensor detects motion in real-time. If the sensor starts to detect motion, there is a 10-second delay to see if the movement just passes or stays in place. If it's just a pass, the tool will not count the move as a visit. However, if the movement lasts for 10 seconds, then the movement is considered a visit. To detect visitors leaving the location, a 10-second delay is also used. If for 10 seconds there is no movement at all, then the visitor is considered to have left the location.

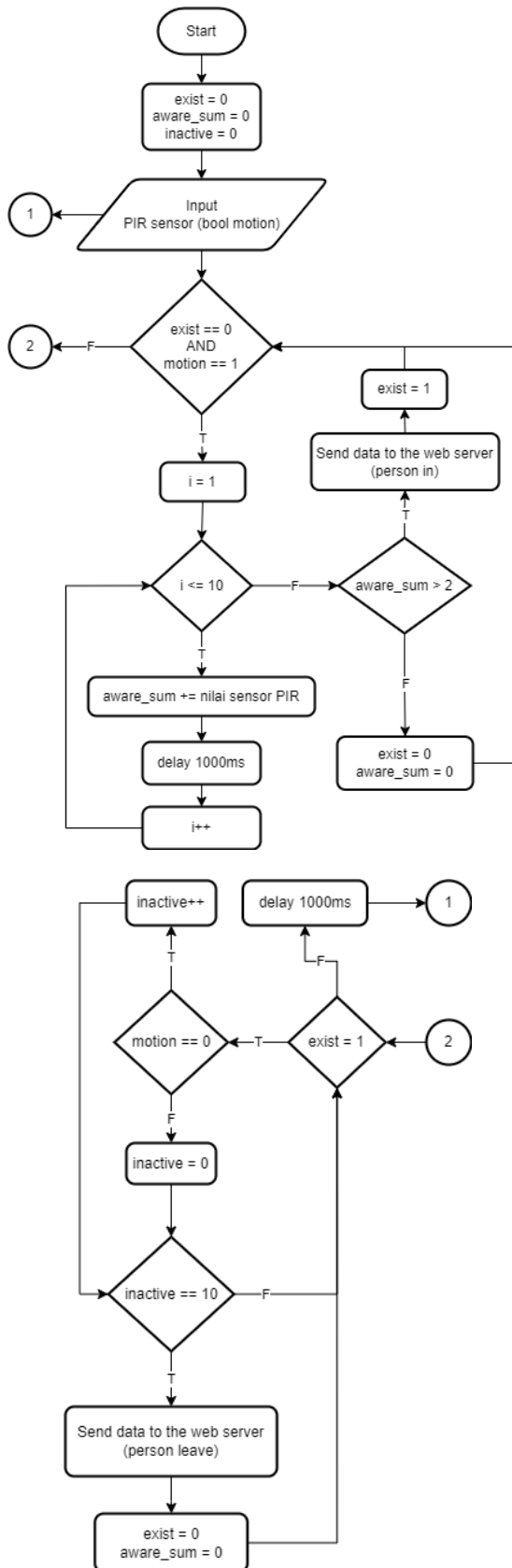

Figure 6. Flowchart of algorithm that used in embedded system.
Source: (Gautama et al., 2022)

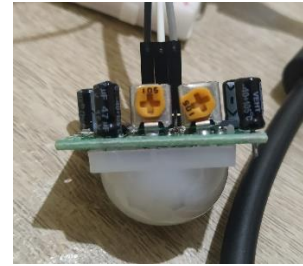

Figure 7. PIR sensor potentiometer setting.
Source: (Gautama et al., 2022)

C. Implementation

At this stage, device components are assembled based on the designs that have been made, and the code is developed based on the flowchart. Figure 8 shows the assembled device that being placed in the case.



Figure 8. The finished device in a case.
Source: (Gautama et al., 2022)

Figure 9 shows a piece of codes that are embedded into the microcontroller. Arduino IDE is used to write, compile, debug, and embed the codes into the microprocessor. The codes are written in C programming language. The embedded system also utilizes the built-in LED from the microcontroller which is used as an indicator of the presence or absence of detected visitors.

```
void loop() {
  int motion = digitalRead(D7);
  if(exist == 0 && motion == 1) {
    for(int i = 1; i <= 10; i++) {
      aware_sum += digitalRead(D7);
      delay(1000);
    }
    Serial.println(aware_sum);
    if(aware_sum > 2) {
      Serial.println("Visitor is detected");
      sendData(1);
      digitalWrite(D3, HIGH);
      exist = 1;
    } else {
      exist = 0;
      aware_sum = 0;
    }
  }
}
```

Figure 9. A piece of codes of the embedded system.
Source: (Gautama et al., 2022)

D. Device Testing

Based on the tests carried out, the device has been able to detect visitors who are in the detection area for more than 10 seconds. However, if there is more than one visitor in the detection area with an interval of fewer than 10 seconds, only one visitor is counted.

2. Web Service Development

In accordance with the Scrum model, the following steps are carried out in this stage:

- Backlog
Breaking down the main work into small parts consisting of features/modules of the web service. The features are arranged based on a priority scale.
- Sprints
Implement features in accordance with the backlog that has been prepared. One sprint can be done by completing more than one feature according to the weight score of the feature.
- Review
Evaluate the features that have been completed for further testing. If something goes wrong at this stage, those features can be returned to the backlog to re-sprint.

A. Backlog

Table 1 below shows the backlogs of the web service that was built. There are a total of four features developed. Each feature has a priority to work on. Estimation columns are filled with how many sprints it is required to complete the tasks. One sprint is done in 7 days or one week.

Tabel 1. Backlogs of the developed system.

ID	Story	Estimation	Priority
1	The system can store event logs consisting of the date and time when the visitor entered the area and when the visitor left the area. The system also stores event data that is currently active.	0.5	1
2	The system can process the data sent by the device. The data has a boolean type, namely 1 when a visitor enters the area and 0 when a visitor leaves the area.	1	2
3	The system can display details/logs of visitor data.	0.5	3
4	The system can display information when visitors have visited the area.	0.5	4

Source: (Gautama et al., 2022)

B. Sprint

1. Sprint ID #1

This sprint is completed by creating a data model that is implemented in the MySQL RDBMS. The data model is a relational type that consists of one table, namely the logs table. Figure 10 below is a schema diagram that shows the structure of the table:

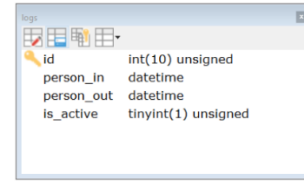

Figure 10. Structure of logs table.

Source: (Gautama et al., 2022)

2. Sprint ID #2

This sprint is completed by creating a single PHP file that implemented the algorithm shown in Figure 11.

Testing is done by activating the device so that data is sent to the web server when the event is triggered. The data sent by the device is successfully processed by the web server with an indicator that the data is successfully stored in the database according to the event that occurred.

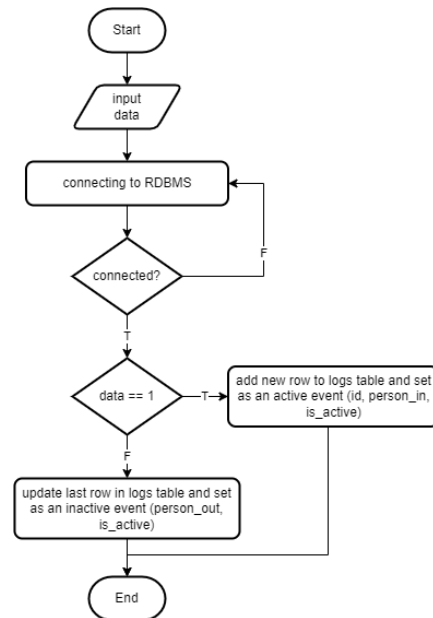

Figure 11. Device data handling algorithm.

Source: (Gautama et al., 2022)

3. Sprint ID #3

This sprint is completed by creating a PHP file that displays the data stored in the logs table. Figure 12 shows the mockup of the web page.

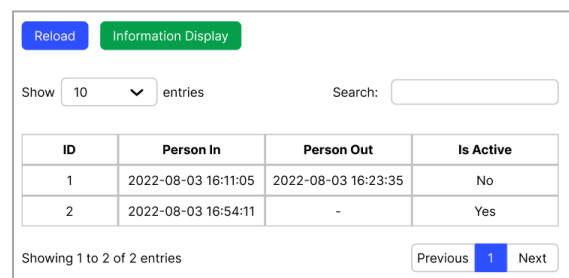

Figure 12. Logs page mockup.

Source: (Gautama et al., 2022)

The mockup was created using Figma. Figma is one of the tools for creating wireframe, mockup, or even prototype of the application. For the front side script, CSS and JS library or CSS Framework Bootstrap 5 is used. DataTables v1.12.1 is also used to generate features on HTML table that are searching, pagination, and sorting. DataTables is a jQuery plugins. Figure 13 shows the results of the implementation. Based on the tests, this feature has functioned as needed.

ID	Person In	Person Out	Is Active
168	2022-08-04 08:25:32	2022-08-04 08:26:05	0
169	2022-08-04 08:40:10	2022-08-04 08:40:22	0
170	2022-08-04 08:59:09	2022-08-04 08:59:44	0
171	2022-08-04 09:00:17	2022-08-04 09:00:31	0
172	2022-08-04 09:02:23		0
173	2022-08-04 09:14:32	2022-08-04 09:14:45	0
174	2022-08-04 09:20:02	2022-08-04 09:20:13	0
175	2022-08-04 09:33:16	2022-08-04 09:33:28	0
176	2022-08-04 09:47:00	2022-08-04 09:47:28	0
177	2022-08-04 10:05:09	2022-08-04 10:05:21	0

Figure 13. Logs page.
Source: (Gautama et al., 2022)

4. Sprint ID #4

This sprint is completed by creating 2 PHP files. The first file is a web page that is accessed/displayed by a computer device connected to the projector. The page sends requests using AJAX periodically to the second page, to check for events that occur. The second page contains a script to check for event updates, for example, whether there are visitors who enter the area or visitors who leave the area which can be known based on real-time data in the logs table. Event data that is queried from the second page, is returned (response) in JSON format to the first page. On the first page, if no visitors have been detected yet, the web page displays only black color. If a visitor is detected, the display is created based on the mockup shown in Figure 14.



Figure 14. Photo information mockup.
Source: (Gautama et al., 2022)

Figure 15 below shows the result of the implementation. Based on the test, the system can display a black screen when there are no visitors, display information when a visitor enters the area, and display a black screen again when the visitor leaves the area.

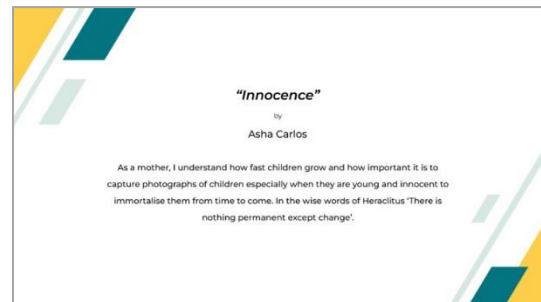

Figure 15. Photo information page.
Source: (Gautama et al., 2022)

C. Review

Based on the suitability test between the needs/stories and the implementation, all the developed features are working functionally so that no part is returned to the backlog and no new features need to be added to the backlog.

3. Device and Web Testing

Testing has not been carried out at the photo exhibition location yet, this is because photo exhibitions are still rarely found related to the COVID-19 pandemic situation, so community activities are limited. The trial was conducted at the STIKOM Bali library using two computers. The first computer was used for library members to record their visits to the library by filling out the form manually. The device was planted in this computer area. The second computer is used to display the information page, to find out whether the information appears when a visitor is detected. If there is a visitor who uses a computer to record his visit, the visitor spends some time so that the device also detects the visit. These two data are compared to test the level of accuracy of the device. The test was carried out for one day, on August 4, 2022. Table 2 shows the visit data recorded manually on the library system.

Tabel 2. Visitor data that collected using the form.

Member ID	Visitor Name	Visit Date
180030864	Visitor 1	2022-08-04 08:25:53
190030041	Visitor 2	2022-08-04 08:40:11
190030672	Visitor 3	2022-08-04 08:59:11
190030002	Visitor 4	2022-08-04 08:59:31
190030054	Visitor 5	2022-08-04 09:00:18
190030348	Visitor 6	2022-08-04 09:02:21
150030682	Visitor 7	2022-08-04 09:14:33
190030474	Visitor 8	2022-08-04 09:20:01
190030151	Visitor 9	2022-08-04 09:33:14
190030534	Visitor 10	2022-08-04 09:47:00
190030215	Visitor 11	2022-08-04 09:47:14
190030403	Visitor 12	2022-08-04 10:05:11
190030447	Visitor 13	2022-08-04 10:20:21
180030438	Visitor 14	2022-08-04 11:08:02
180030510	Visitor 15	2022-08-04 11:08:24
210030334	Visitor 16	2022-08-04 11:34:14
210050099	Visitor 17	2022-08-04 11:34:40
150030181	Visitor 18	2022-08-04 11:55:56
180030002	Visitor 19	2022-08-04 11:57:08
190030631	Visitor 20	2022-08-04 12:31:05
190030480	Visitor 21	2022-08-04 12:31:23
160030559	Visitor 22	2022-08-04 12:32:40
190020012	Visitor 23	2022-08-04 12:36:24
190020005	Visitor 24	2022-08-04 12:36:35
190030398	Visitor 25	2022-08-04 12:40:02
190030015	Visitor 26	2022-08-04 12:51:35
160030702	Visitor 27	2022-08-04 12:56:11
160010258	Visitor 28	2022-08-04 13:03:57
190030203	Visitor 29	2022-08-04 13:06:37
190030138	Visitor 30	2022-08-04 13:23:36
180030856	Visitor 31	2022-08-04 15:09:34
200030521	Visitor 32	2022-08-04 16:22:22
200010080	Visitor 33	2022-08-04 17:12:34

Source: (Gautama et al., 2022)

Table 3 shows the data stored in the logs table in the database. The data displayed is data recorded on August 4, 2022.

Tabel 3. Data collected by the device.

id	person_in	person_out	is_active
168	2022-08-04 08:25:32	2022-08-04 08:26:05	0
169	2022-08-04 08:40:10	2022-08-04 08:40:22	0
170	2022-08-04 08:59:09	2022-08-04 08:59:44	0
171	2022-08-04 09:00:17	2022-08-04 09:00:31	0
172	2022-08-04 09:02:23	NULL	0
173	2022-08-04 09:14:32	2022-08-04 09:14:45	0
174	2022-08-04 09:20:02	2022-08-04 09:20:13	0
175	2022-08-04 09:33:16	2022-08-04 09:33:28	0
176	2022-08-04 09:47:00	2022-08-04 09:47:28	0
177	2022-08-04 10:05:09	2022-08-04 10:05:21	0
178	2022-08-04 10:20:22	2022-08-04 10:20:33	0
179	2022-08-04 11:08:00	2022-08-04 11:08:37	0
180	2022-08-04 11:34:14	2022-08-04 11:34:57	0
181	2022-08-04 11:55:55	2022-08-04 11:56:08	0
182	2022-08-04 11:57:08	2022-08-04 11:57:19	0
183	2022-08-04 12:31:06	2022-08-04 12:31:33	0
184	2022-08-04 12:32:40	2022-08-04 12:32:51	0
185	2022-08-04 12:36:23	2022-08-04 12:36:46	0
186	2022-08-04 12:40:02	2022-08-04 12:40:13	0
187	2022-08-04 12:51:33	2022-08-04 12:51:45	0
188	2022-08-04 12:56:12	2022-08-04 12:56:23	0
189	2022-08-04 13:03:55	2022-08-04 13:04:07	0
190	2022-08-04 13:06:36	2022-08-04 13:06:47	0
191	2022-08-04 13:23:36	2022-08-04 13:23:48	0
192	2022-08-04 15:09:35	2022-08-04 15:09:46	0
193	2022-08-04 16:22:20	2022-08-04 16:22:34	0
194	2022-08-04 17:12:35	2022-08-04 17:12:50	0

Source: (Gautama et al., 2022)

4. Evaluation

Based on the experiments, out of 33 visitors, only 27 were detected by the device (82% accuracy). The second computer successfully displays information when a visitor is detected and hides information when a visitor leaves the detection area. In addition, the device experienced one failure to update an event so the recorded data was NULL. Below are the discussions of the visits that were not successfully recorded by the device.

The device cannot count more than one visitor who comes together or come alternately in a period of less than or equal to 10 seconds. If this happens, only one visitor has been detected. This is proven by the piece of data in Table 2 which is shown in Table 4 below.

Tabel 4. Piece of data when visitors came almost at the same time

190030041	Putu Indah Tia Wahyuni	2022-08-04 08:40:11
190030672	I Gede Endy Permana Putra	2022-08-04 08:59:11
190030002	Ida Bagus Fajar Prabawa Manuaba	2022-08-04 08:59:31
190030054	I Gusti Ayu Bulan Arta Ningrum	2022-08-04 09:00:18

Source: (Gautama et al., 2022)

In Table 4, the data in the second and third rows were recorded manually at almost the same time (interval of 20 seconds). When the first visitor leaves the detection area, there is a 10-second delay for the sensor to read the movement update. If within 10 seconds there is no movement at all, then the visitor is confirmed to have left the detection area. In this case, when the first visitor leaves the detection area, before 10 seconds, the second visitor enters the detection area. Thus, the device reads that the movement of the second visitor came from the first visitor who had been silent for some time less than 10 seconds. Table 5 shows two visitors recorded as one visitor, marked with a yellow row.

Tabel 5. The piece of data from the device when more than one visitor counted as one

169	2022-08-04 08:40:10	2022-08-04 08:40:22	0
170	2022-08-04 08:59:09	2022-08-04 08:59:44	0
171	2022-08-04 09:00:17	2022-08-04 09:00:31	0

Source: (Gautama et al., 2022)

The event of a visitor leaving the detection area failed to be recorded on the data with ID 172, possibly due to an unstable internet connection. When the device sends its data to the web server, the access point is interrupted so that the data is not sent.

CONCLUSION

Based on this research, a device that is built using the IoT concept has been produced. The device can be

used to detect visitors and display information at photography exhibitions or similar cases. The device is made using the NodeMCU as the main board and the PIR sensor is used to detect visitor movements. With modifications in sensor cases, sensor placement techniques, and detection algorithms, the device is able to detect visitors with an accuracy of 82%, send data to a web server, and display information only when visitors enter the detection area. The device is relatively inexpensive compared to previous studies, so it can be used if needed in large quantities but with a low budget. However, this tool has the disadvantage of not being able to count visitors correctly if more than one visitor comes at the same time or come alternately in less than 10 seconds.

REFERENCES

- Adella, A. F., Fardika, M., Putra, P., Taufiqurrahman, F., & Kaswar, A. B. (2020). Pintu Otomatis Berbasis Ultrasonic Internet of Things. *Jurnal MEDIA ELEKTRIK*, 17(3), 80–84.
- Almuttaqin, & Nasir, M. (2021). Rancang Bangun Alat Penghitung Jumlah Pengunjung Di Perpustakaan Politeknik Negeri Bengkalis Berbasis Mikrokontroler. *Seminar Nasional Industri Dan Teknologi (SNIT)*, 385–394.
- Arbi, F., & Dewi, S. I. (2017). Pengaruh Media Sosial Instagram Terhadap Minat Fotografi pada Komunitas Fotografi Kamera Indonesia Malang. *JISIP: Jurnal Ilmu Sosial Dan Ilmu Politik*, 6(2), 69–74.
- Atika Sari, A., Fitrianto Rahmad, I., & Tambunan, F. (2020). Perancangan Dan Implementasi System Pendeteksi Pengunjung Pada Toko Berbasis Arduino. *Jurnal FTIK*, 1(1), 417–428. <http://e-journal.potensi-utama.ac.id/ojs/index.php/FTIK/article/view/8>
- 77
- Fahmawaty, M., Royhan, M., & Mahmudin. (2020). Perancangan Alat Penghitung Jumlah Pengunjung Di Perpustakaan Unis Tangerang Menggunakan Sensor Pir Berbasis IoT. *JIMTEK : Jurnal Ilmiah Fakultas Teknik*, 1(3), 253–261. www.thingspeak.com
- Gautama, I. M. B., Arsa, I. G. N. W., & Savita, N. P. V. (2022). *Visitor Counter and Information Viewer at Photo Exhibitions using Embedded Systems and Web Services*.
- Inrawansyah, M. N. (2017). Implementasi Face Detection Menggunakan Metode Viola Jones Untuk Membantu Mempermudah Proses Counter Pengunjung Gedung. *Jurnal Mahasiswa Teknik Informatika*, 1(1), 8–16.
- Irawan, R. F., & Deli, D. (2021). Studi Deskripsi Spesifikasi Tehnis dari Kamera Mirroless untuk Mengambil Foto Secara Artistik. *Conference on Business, Social Sciences and Innovation Technology*, 1(1), 695–701.
- P, R. A., Achmadi, S., & Auliasari, K. (2022). Penerapan Metode Convolutional Neural Network pada Aplikasi Deteksi Wajah Pengunjung Perpustakaan. *Jurnal Mahasiswa Teknik Informatika*, 6(1), 253–258.
- Pebriany, srie A., & Sanusi, N. (2020). Fotografi Instagram: Studi Literatur. *Buana Komunikasi, Jurnal Penelitian Dan Studu Ilmu Komunikasi*, 1(2), 92–101.
- Rabbani, I., & Krisnanik, E. (2020). E-Commerce Perlengkapan Haji Dan Umroh Berbasis Web Menggunakan Metode Agile Software Development. *Seminar Nasional Mahasiswa Ilmu Komputer Dan Aplikasinya (SENAMIKA)*, 1(2), 432–443.